

# Optimization and Complexity Reduction of Switch-Reconfigured Antennas using Graph Models

J. Costantine, Student Member IEEE, C. G. Christodoulou, Fellow Member IEEE, C. T. Abdallah, Senior Member IEEE, S. E. Barbin, Senior Member IEEE

**Abstract-** This paper addresses the optimization and complexity reduction of switch-reconfigured antennas. A new optimization technique based on graph models is investigated. This technique is used to minimize the redundancy in a reconfigurable antenna structure and reduce its complexity. A Graph modeling rule for switch-reconfigured antennas is proposed and examples are presented.

**Index Terms**—Reconfigurable Antennas, Graph Models, Optimization, Complexity, Switches.

## I. INTRODUCTION

The reconfiguration of an antenna may be achieved through many techniques. Some designers resort to circuit elements while others rely on mechanical alteration of the structure such as rotating or bending of one or more of its parts [1]. Yet other approaches bias different antenna parts at different times, reconfigure the feeding networks or appropriately excite the antenna arrays [2]. All such approaches have significantly contributed to the evolution of reconfigurable antennas during the last decade. More recently, antenna designers have used electrically-actuated switches in order to achieve reconfiguration [3-4]. PIN diodes and RF MEMS are some of the most widely used electrically-actuated devices.

Installing such switches on the antenna structure requires biasing lines and costly hardware for their activation and deactivation. If control is to be achieved using a microchip or a Field Programmable Gate Array (FPGA), a specific algorithm as well as its associated software must be developed while accounting for the system's complexities.

The usage of RF components in the reconfiguration of antenna structures made such structures even more complex, and has left designers puzzled between the conflicting requirements of enhanced performance and increased complexity. In this paper, we propose an optimization technique using graph theoretical model in order to decrease the structure complexity, without compromising the desired antenna performance.

Manuscript received July 6, 2009; Revised September 08, 2009.

J. Costantine, C. G. Christodoulou, and C.T.Abdallah are with the Electrical and Computer Engineering Department, University of New Mexico, Albuquerque, NM 87131-0001, USA

S. E. Barbin is with university of Sao Paulo, 05508-900 Sao Paulo, Brazil and with the Center for Information Technology, Renato Archer Department of Science and Technology of the Brazilian Government, 13069-901 Campinas, Sao Paulo, Brazil.

## II. GRAPH MODELS

### a. Introduction:

A graph is a collection of vertices connected together by lines called edges or links [5]. A simple labeled graph is represented by  $G = (V, E)$  where  $V$  is a set of vertices, and  $E$  is a set of pairs or edges of  $V$ . A graph may be either directed or undirected. In a directed graph, the edges have a determined direction while in an undirected graph edges may be traversed in either direction. Fig. 1 shows an undirected graph of 7 vertices ( $V_1, V_2, V_3, V_4, V_5, V_6, V_7$ ) connected by 8 edges. The vertices represent physical entities and the edges indicate the existence of functions relating these entities. If one is graph modeling antennas, then a possible modeling rule may be to create an edge between two vertices whenever their physical connection results in a meaningful antenna function.

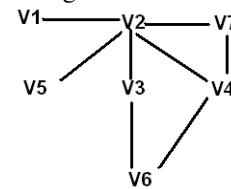

Fig.1. An example of an undirected graph

Edges may have weights associated with them in order to represent costs or benefits that are to be minimized or maximized. A path is an ensemble of edges connecting two vertices and its weight is defined as the sum of the weights of its constituent edges. For example if a capacitor is connecting two end points of a system and these end points are represented by two vertices in a graph, then the edge connecting these two vertices has a weight equal to the capacitance of that capacitor. Or in if a switch is connecting two parts of an antenna system then a weight might represent the connection distinctive direction.

In some cases, it is useful to find the shortest path connecting two vertices. This notion is used in graph algorithms in order to optimize a certain function. The shortest path in a non-weighted graph is defined as the path having the minimum number of edges among all paths connecting the vertices of interest. Otherwise, if the graph is weighted, the shortest path corresponds to the one with the least sum of weights. In a reconfigurable antenna design, a shorter path may mean a shorter current flow path, and thus an associated resonance frequency (usually a high resonance frequency). A longer path may denote a lower resonance frequency instead.

### a. How to graph model reconfigurable antennas?

There are several ways of graph modeling reconfigurable antennas. According to our analysis of previous publications in this particular area, we set a rule to graph model switch-reconfigured antennas. This rule is not unique; however it is required to achieve the desired optimization. We set some constraints to facilitate the graph modeling process. These constraints explain how to graph model this particular type of reconfigurable antennas.

### III. GRAPH MODELING OF SWITCH RECONFIGURED ANTENNAS

Herein an antenna is called a multi-part antenna if it is an array composed of identical or different elements (triangular, rectangular, etc...). Otherwise it is called a single-part antenna. In this paper only multi-part antennas are considered.

*Graph modeling rule: The graph modeling of a multi-part antenna whose parts are connected by switches is undirected and has weighted edges connecting the vertices that represent its different parts.*

#### Constraints:

The connection between any two parts has a distinctive angular direction. The designer defines a reference axis that represents the direction that the majority of parts have with each other or with a main part. The edges' weights represent the angles that the connections make with the reference axis. A weight  $W=1$  is assigned to an edge representing a connection that has an angle  $0^\circ$  or  $180^\circ$  with the reference axis. Otherwise, a weight  $W=2$  is assigned to the edge, as indicated in Eq. (1).

$$W_{ij} = W_{ji} = P_{ij} \quad (1)$$

$$\text{Where } P_{ij} = f(A_{ij}) = \begin{cases} 1 & A_{ij} = 0^\circ \text{ or } 180^\circ \\ 2 & \text{Otherwise} \end{cases}$$

$A_{ij}$  represents the angle of the edge between nodes  $i, j$  and the reference axis.

The edges' weights in the graph model are then assembled in a matrix called the adjacency matrix.

#### Example:

As an example, the antenna shown in Fig.2 and taken from reference [3] will be graph-modeled following the aforementioned rule. The antenna is built out of a hexagonal main patch and six trapezoidal parts placed around it. One of the trapezoidal parts is selected for the definition of the reference axis direction, as shown in Fig.2. The other parts are placed at angles referred to this axis, in such a way that a hexagon shaped patch is formed. The vertices representing the different parts in the graph model are denoted by  $P_0, P_1, P_2, P_3, P_4, P_5$  and  $P_6$ . The edges correspond to the connections between all the trapezoidal parts and the main patch as shown in Fig.2. The edges' weights represent the parts' directions with respect to the reference axis and are determined according to Eq.1, as follows:

$$W_{10} = W_{01} = f(0^\circ) = 1$$

$$W_{20} = W_{02} = f(60^\circ) = 2$$

$$W_{30} = W_{03} = f(120^\circ) = 2$$

$$W_{40} = W_{04} = f(180^\circ) = 1$$

$$W_{50} = W_{05} = f(240^\circ) = 2$$

$$W_{60} = W_{06} = f(300^\circ) = 2$$

The adjacency matrix  $A$  is shown below:

$$A = \begin{bmatrix} W_{00} & W_{01} & W_{02} & W_{03} & W_{04} & W_{05} & W_{06} \\ W_{10} & W_{11} & W_{12} & W_{13} & W_{14} & W_{15} & W_{16} \\ W_{20} & W_{21} & W_{22} & W_{23} & W_{24} & W_{25} & W_{26} \\ W_{30} & W_{31} & W_{32} & W_{33} & W_{34} & W_{35} & W_{36} \\ W_{40} & W_{41} & W_{42} & W_{43} & W_{44} & W_{45} & W_{46} \\ W_{50} & W_{51} & W_{52} & W_{53} & W_{54} & W_{55} & W_{56} \\ W_{60} & W_{61} & W_{62} & W_{63} & W_{64} & W_{65} & W_{66} \end{bmatrix} = \begin{bmatrix} 0 & 1 & 2 & 2 & 1 & 2 & 2 \\ 1 & 0 & 0 & 0 & 0 & 0 & 0 \\ 2 & 0 & 0 & 0 & 0 & 0 & 0 \\ 2 & 0 & 0 & 0 & 0 & 0 & 0 \\ 1 & 0 & 0 & 0 & 0 & 0 & 0 \\ 2 & 0 & 0 & 0 & 0 & 0 & 0 \\ 2 & 0 & 0 & 0 & 0 & 0 & 0 \end{bmatrix}$$

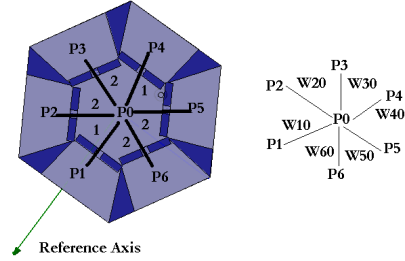

Fig.2 Antenna Structure in [3] and its graph model for all possible connections

### IV. THE OPTIMIZATION APPROACH

#### Introduction:

Our approach enables the optimization of the number of switches used to reconfigure an antenna. The technique aims at removing redundancies from the structure in order to reduce costs and losses.

#### Redundancy:

The objective at this stage is to determine the existence of redundant elements in a structure and to eliminate them. A part is defined as redundant in a switch-reconfigurable antenna if its presence gives the antenna more functions than required and its removal does not affect the antenna's desired performance. The removal of a part from the antenna structure may require a change in the dimensions of the remaining parts in order to preserve the antenna original characteristics.

If the number of unique paths in the graph model is larger than the number of configurations, then redundancy might exist in the antenna structure. An example of counting the total number of unique paths in a graph model is shown in Fig. 3.

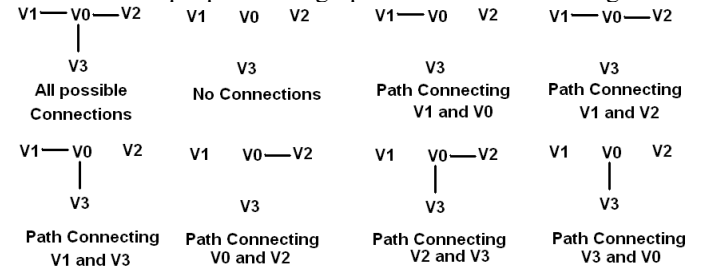

Fig.3. An example of all possible unique paths in a given graph

The Basic Optimization Approach:

In this section, NUP represents the necessary number of unique paths in a graph, NAC represents the necessary antenna configurations, and N is the number of vertices in the corresponding graph model. Since a unique path existing in a graph representing an antenna represents a unique function achieved by that particular antenna, it is important to identify the number of possible unique paths. Here we show our approach of determining the number of unique paths for switch-reconfigured antennas.

Based on the graph modeling rule set in section III, we derive the set of equations (Eq.\_2a,b,c), in two stages: Stage 1 takes into consideration graphs where  $N < 4$ . In that case the total number of unique paths is easy to calculate and is shown in Eq.\_2a. Stage 2 (for  $N \geq 4$ ) however estimates a minimum necessary bound of unique paths in a graph model to achieve a trustworthy design. This estimated number is shown in Eq.\_2a. The reconfigurable antenna might have more possible configurations than NAC for a given set of vertices however NAC represents the minimum bound of configurations that are necessary to achieve a reliable antenna.

This set of equations is valid only for multi-part switch reconfigured antennas. Eq.\_2b adds to the number of unique paths estimated in Eq.\_2a the cases where the graph is fully or not connected. Eq.\_2c adds to Eq.\_2a the case where the graph is not connected since the fully connected graph case is considered in Eq.\_2a for  $N < 4$ .

$$NUP = \frac{N(N-1)}{2} \quad (2a)$$

$$NAC = NUP + 2 \quad N \geq 4 \quad (2b)$$

$$NAC = NUP + 1 \quad N < 4 \quad (2c)$$

$$N^2 - N - 2 \times (NAC - 1) = 0 \Rightarrow$$

$$N = \left\lceil \frac{1 + \sqrt{1 + 8 \times (NAC - 1)}}{2} \right\rceil \quad (2d)$$

Example 1:

In this section, the antenna discussed in [6] is considered. The antenna is required to have resonance tuning and radiation pattern reconfigurability. The design in [6] is presented in Fig.4. The antenna structure consists of 3 layers. The bottom layer constitutes the square ground plane that covers the entire substrate. The middle substrate has a dielectric constant  $\epsilon_r=3.9$  and a height of 0.16 cm. The upper layer is composed of 4 microstrip lines intersecting each other. The antenna designer proposed switches to achieve reconfiguration by attaching and detaching microstrip lines to a middle section, as shown in Fig.4. The graph model of this antenna follows the rule of section III and is shown in Fig. 4.

This antenna was required to have 5 different configurations. Applying Eq. 2a,b however, reveals that the antenna has a minimum of 30 possible configurations.

$$NUP = \frac{N(N-1)}{2} = \frac{8(8-1)}{2} = 28$$

$$NAC = NUP + 2 = 30$$

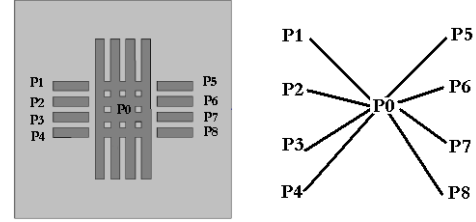

Fig.4. Antenna Structure in [6] and its graph model

Since the total number of possible configurations is larger than the required antenna configurations, redundancy exists. In order for the antenna to present only 5 configurations without compromising its originally required performance, 4 vertices are needed according to Eq.2c as shown below:

$$NAC = 5$$

$$N = \left\lceil \frac{1 + \sqrt{1 + 8 \times (NAC - 1)}}{2} \right\rceil = \left\lceil \frac{1 + \sqrt{1 + 8 \times (5 - 1)}}{2} \right\rceil = 4$$

Fig.5. Graph model with 4 vertices

The graph model with 4 vertices is shown in Fig.5. It is composed of 3 vertices (P1, P2, P3) connected to a main vertex (P0). This graph model will be translated by reversing the rule of section III into an antenna with 3 parts attached to a main part. This process doesn't preserve the structure symmetry. The optimization technique allows for the removal of redundant parts as long as their removal does not affect the antenna characteristics such as symmetry. Therefore 4 total parts as represented by the 4 vertices is not a good solution for this antenna and in such a case,  $N > 4$  is required. Taking  $N=5$  leads to  $NAC=12$  according to Eq.\_2 a,b.

$$NUP = \frac{N(N-1)}{2} = \frac{5(5-1)}{2} = 10$$

$$NAC = NUP + 2 = 12$$

The resulting antenna is shown in Fig.6 and is seen to preserve the symmetry of the structure. To verify the validity of our approach, the original and the optimized antennas were simulated using HFSS V11. The lines have now a width of 0.9 cm and a length of 1.15 cm. The return loss results are very similar for both antennas as show in Fig. 7 for comparison. This confirms that the removed parts as well as the 4 switches that were used in the original antenna were redundant. The radiation patterns of the original and the optimized antennas are compared in Fig. 8 while the switches are in the non-activated state (OFF). The similarity between the patterns confirms that the removal of the redundant parts did not drastically affect the radiation characteristics. The optimal antenna was fabricated and tested. A comparison between the tested and the simulated results for S11 is shown in Fig.9.

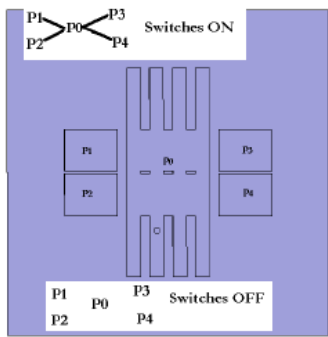

Fig.6. The optimal structure and its graph model

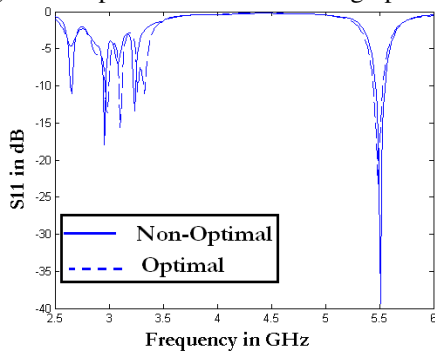

Fig.7. Comparison between the S11 results for the non-optimal and the optimal antenna when the switches are activated

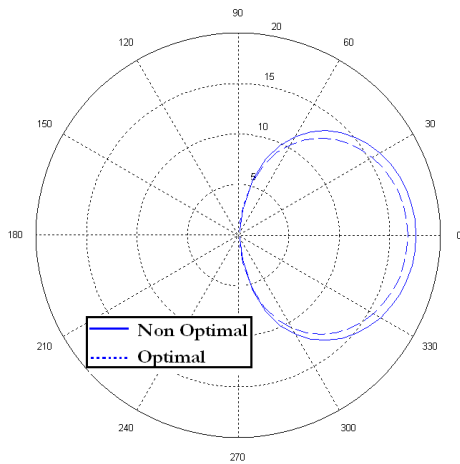

Fig.8. The radiation pattern for the original and the optimal antenna when the switches are open.

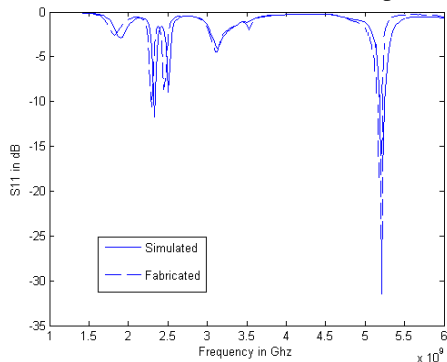

Fig.9. A comparison between the simulated and tested S11 results for the optimal antenna

## V. RECONFIGURABLE ANTENNAS COMPLEXITIES

Every edge in a graph model of a reconfigurable antenna represents a connection between two nodes. An increase in the number of edges represents an increase in the reconfigurable antenna's structure complexity. Therefore a measure of the complexity may be defined as the total number of edges existing in a particular graph for all possible connections. This definition of complexity is different than other definitions such as computational complexity. Herein we define:

$$C = NE \quad (3)$$

where C represents the complexity of a reconfigurable antenna and NE represents the number of edges for all possible connections.

The removal of redundant elements results in a reduction of the complexity of the hardware as well as the software controlling the reconfiguration. This complexity reduction helps in simplifying algorithms set for the control of such antennas and quantifies the optimization process. Using Eq. 3 we review next how complexity was decreased using our optimization technique.

### Case 1:

The complexity of the antenna in Fig.4 according to Eq. 3 is:  $C = 8$ . However after applying the optimization technique the complexity of the structure in Fig.6 is equal to 4.

## VI. Conclusion

In this paper a new optimization technique for reconfigurable antennas is presented using graph models. This technique optimizes switch-reconfigurable antennas in the sense of removing redundant parts. It minimizes the structure complexity of a reconfigurable antenna leading to cost and losses reduction. The optimization and the complexity minimization facilitate control and the development of the associated programming process for reconfigurable antennas. The notion of complexity reduction helps in future work when graph algorithms are addressed. Easier implementation of switch-reconfigurable antennas is achieved. The method was validated through many examples.

## VII. REFERENCES

- [1] J.Costantine,C.G.Christodoulou " A New Reconfigurable Antenna Based on A Rotated Feed" IEEE International Symposium On Antennas and Propagation, pp.1-4, July 2008
- [2] A.E. Fathy, A. Rosen, H.S.Owen, F. McGuinty, D.J. Mcgee, G.C. Taylor, R. Amantea , P.K. Swain, S. M. Perlow and M. Elsharbiny " Silicon-based reconfigurable antennas-concepts, analysis, implementation and feasibility " IEEE Transactions on Microwave Theory and Techniques , Vol. 51,Issue 6, pp. 1650-1661, June 2003.
- [3] J. Costantine, C. G. Christodoulou, S. E. Barbin, "A New Reconfigurable Multi-Band Patch Antenna", IEEE IMOC Conference, Salvador, Brazil, pp.75-78,October 2007.
- [4] V. Zachou, C.G.Christodoulou, M.T.Chrysomallis, D.Anagnostou and S.E. Barbin, "Planar Monopole Antenna With Attached Sleeves", Antennas and Wireless Propagation Letters, Vol. 5 No 1, pp. 286-289, Dec. 2006.
- [5] T.H.Cormen, C.E.Leiserson, R.L.Rivest, C.Stein "Introductions to Algorithms", MIT press, 2<sup>nd</sup> edition, 2001.
- [6] D.Ressiguier, J.Costantine, Y.Tawk, C.G.Christodoulou "A Reconfigurable Multi-Band Microstrip Antenna Based on Open Ended Microstrip Lines" 3<sup>rd</sup> European Conference on Antennas and Propagation, pp.792-795, March 2009