

A TEMPERATURE COMPENSATED L-BAND HYBRID SAW OSCILLATOR AND RESONATOR FILTER

J. Ladd, C. Abdallah, and T. O'Shea
Sawtek Inc.
Post Office Box 18000
Orlando, FL 32860

ABSTRACT

A 950 MHz subminiature temperature compensated SAW resonator oscillator (TCSO) and a SAW resonator filter are developed in hybrid form for application as local oscillator and bandpass filter for a communication system. The oscillator package volume is approximately 0.02 cubic inches and the filter package is approximately 0.01 cubic inches. The extremely tight packaging requirements are met by utilizing chip resistors and capacitors, printed spiral inductors, and chip transistors and diodes.

The SAW oscillator consists of a temperature sensing network, a varactor diode tuning circuit, and a single port SAW resonator oscillator. The SAW resonator bandpass filter consists of a four-element input matching network, a two-port two-pole SAW resonator, and four-element output matching network in hybrid form.

INTRODUCTION

This paper describes the design, fabrication and performance of a SAW resonator controlled oscillator and a SAW resonator filter. These circuits utilize hybrid techniques to achieve extremely small size. Temperature compensation is included in the oscillator tuning network in order to minimize frequency shifts. The oscillator performance goals are low phase noise (-50 dBc/Hz at 10 Hz), moderate RF output power (0 dBm), minimal DC power drain, and good frequency stability over the operating temperature range of 0°C to +50°C. The goal for set-on frequency accuracy and frequency drift due to temperature is ± 15 ppm.

The resonator filter was designed and modeled using a transmission matrix approach. Low insertion loss (5 dB) and minimum ripple in the pass band were achieved by including a matching network inside the miniature package and using an overlap apodization scheme on the transducers.

OSCILLATOR DESIGN

A single-port SAW resonator was used in a Pierce-type hybrid oscillator circuit utilizing chip transistors, diodes, resistors and capacitors, and a printed spiral inductor. The circuit diagram of the voltage tuned oscillator is shown in Figure 1. The Pierce oscillator configuration has been shown to require fewer tuning elements and provide better stability than other configurations.¹ The transistor chosen was a bipolar device (HXTR 2001) with 18 dB gain and 2 dB noise figure at 1000 MHz. A bipolar transistor typically exhibits 10 to 15 dB lower phase noise than a comparable field-effect transistor when used in an oscillator of this type.² A resonator was chosen over a delay line as the frequency controlling feedback element because of the low phase noise requirement. The single-port SAW resonator swings inductive at the resonant frequency and is series resonant with the base capacitor, C_b . A varactor diode was included in series with capacitor C_b in order to vary the frequency of oscillation. The varactor diode chosen was an MSI Electronics MV1412. This diode has a nominal value of 10 pf, a tuning ratio of 7.5:1, and a Q of 200 at 1 MHz. Typical frequency pulling of the oscillator was 40 PPM with a tuning voltage of 0 to +6 volts. The RF output power was extracted via a tapped inductor in an LC tank circuit on the collector of the transistor. This approach yields good output power and low harmonic content.

SAW 1-PORT RESONATOR VOLTAGE CONTROLLED OSCILLATOR
PIERCE CONFIGURATION

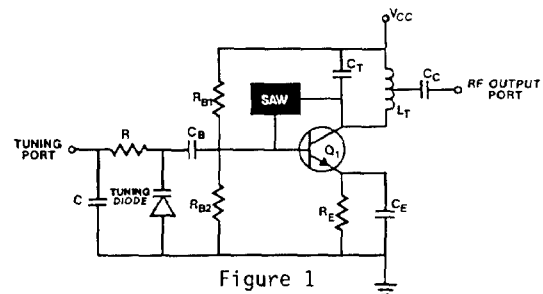

Figure 1

TEMPERATURE COMPENSATION

In order to meet the SAW oscillator frequency accuracy of ± 15 PPM, compensation is required for the frequency drift of the SAW resonator due to environmental temperature changes. The well-known temperature drift characteristic of a SAW resonator on quartz is parabolic with a frequency maximum at the temperature turnover point. Kinsman³ has described a compensation circuit consisting of two series connected varactor diodes driven by a linear voltage versus temperature generator. This approach results in a technique that can be used to compensate any crystal which has a parabolic frequency versus temperature dependence.

The limited temperature range of 0°C to +50°C and the requirement to operate from a six-volt battery required a modified approach to compensate the frequency drift on only one side of the parabolic curve. In this approach, the SAW resonator was fabricated on a quartz substrate with a 36° cut angle to place the frequency turnover near the high end of the temperature range. A single varactor diode is used to compensate the frequency drift on the low side of the temperature range. This approach yields a greater capacitance change (and therefore, a greater frequency change) for a given voltage range. The capacitance versus voltage curves for the two approaches are shown in Figure 2.

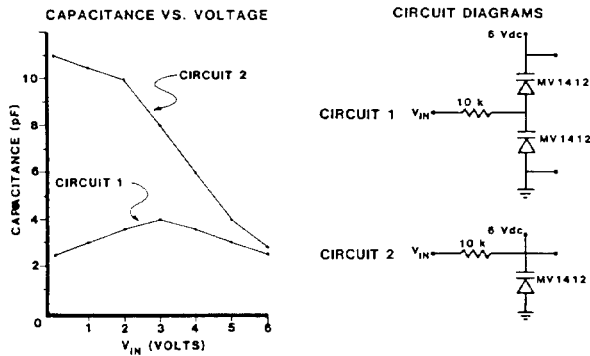

Figure 2

Kinsman suggests that the linear voltage versus temperature function required may be obtained by using the temperature sensitive base-emitter junction voltage of a bipolar transistor connected as a DC amplifier in a common-emitter configuration. In order to achieve greater sensitivity to temperature change a Darlington pair transistor chip (MPSA13) with a current gain (h_{FE}) of 5000 was used. The resistor labeled R_2 in Figure 3

sets the voltage intercept point and resistor R_4 adjusts the voltage slope. These two components were varied to achieve the desired voltage versus temperature curve to be applied to the varactor diode in order to minimize the frequency drift over temperature of the oscillator.

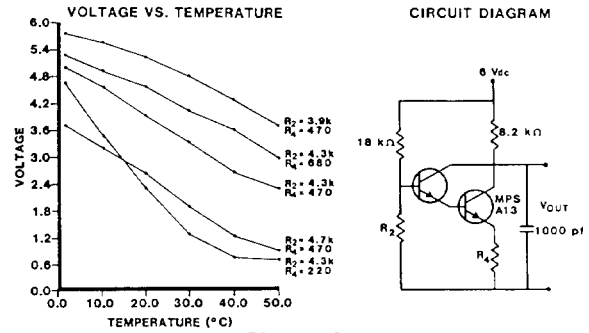

Figure 3

OSCILLATOR CONSTRUCTION

The hybrid oscillator circuit development utilized Epsilam-10 (E-10) for the initial breadboard design and alumina substrate in the final design. Epsilam-10 is a ceramic-impregnated teflon substrate that is electrically similar to alumina. It is flexible, easily cut and drilled and is etchable in ferric chloride, similar to the other common PC materials. The use of chip components on the E-10 substrate allowed direct conversion to the alumina substrate used in the final circuit.

Conductive silver epoxy was used to attach all components to the substrate. Wire bonding was used to form electrical interconnections between the RF transistor, varactor diode, temperature sensor transistor, and SAW resonator. Additional wire bonds were used to attach Vcc, ground, and to "tap" the tank circuit for RF output power. The inductor used in the oscillator is a planar spiral design and an integral part of the hybrid circuit photomask.⁵

The hybrid oscillator is housed in a custom flatpack that is 0.30"W x 0.75"L x 0.085"H. The package has a stepped lid that is seam-welded to the flatpack.

OSCILLATOR PERFORMANCE

The temperature compensated SAW oscillator performance is summarized in Table 1. Phase noise of the oscillator is shown in Figure 4. Typical frequency versus temperature for both temperature compensated and uncompensated oscillators is shown in Figure 5. Output power was 0

dBm ± 0.5 dB over 0°C to +50°C. Greater output power may be achieved at the expense of increased DC power consumption. The frequency accuracy versus temperature could be held over a wider temperature range if a greater supply voltage were available with which to tune the varactor diode. Also, the one-port resonator could be replaced by a two-port resonator or a delay line with a corresponding increase in phase noise and increased circuit complexity. The SAW one-port resonator controlled oscillator typically exhibits 30 to 35 dB better phase noise than a SAW delay line controlled oscillator. The TCSO circuit diagram is shown in Figure 6.

TABLE 1
OSCILLATOR PERFORMANCE

Frequency	950.0 MHz
RF Power	0 dBm ± 0.5 dB
Accuracy/Stability	± 15 ppm
Temperature	0°C to +50°C
Phase Noise	-50 dBc/Hz @ 10 Hz -75 dBc/Hz @ 100 Hz -100 dBc/Hz @ 1000 Hz
Allan Variance ($\sigma_y(\tau)$)	1×10^{-9} ($\tau = 1$ sec)
Supply Voltage	6 V ± 0.2 V
Supply Current	15 mA
Size	.30" x .75" x .085"
Package	Custom Flatpack

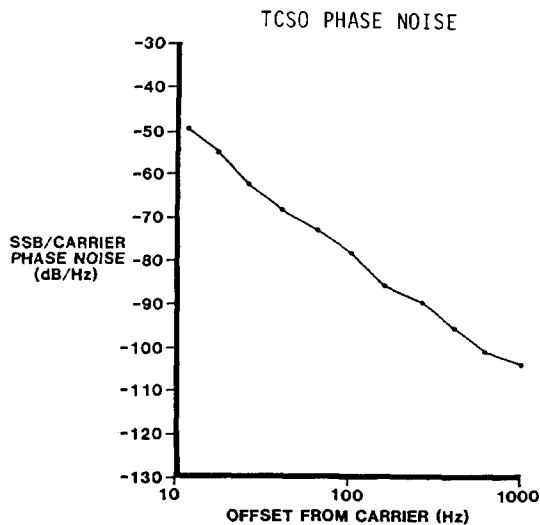
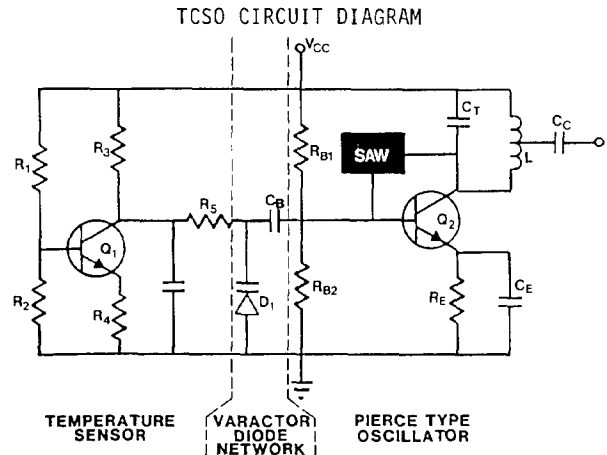
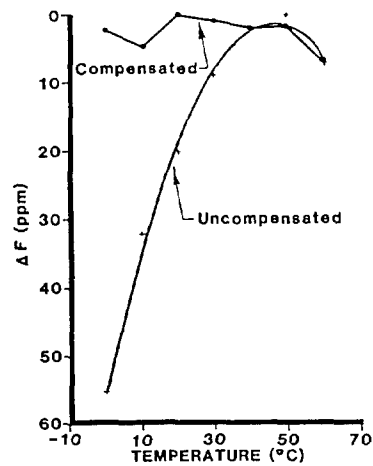

Figure 4



TCSO FREQUENCY vs. TEMPERATURE



FILTER DESIGN

In order to realize a practical SAW resonator filter the SAW filter designer must be concerned with the following: 1) filter synthesis, 2) analysis, 3) practical fabrication parameters, and 4) the implications of packaging constraints. Multipole SAW resonator filter synthesis and design has reached a high level of maturity with the work of Rosenberg and Coldren,⁷ Mattael⁸ and others.⁹ The challenge of our work is achieving low loss with moderate rejection at 950 MHz utilizing integrated matching networks and within a subminiature package.

The goals for the electrical specifications of this filter are listed in Table 2. Using these specifications, it was determined that a two-pole Butterworth, in-line acoustically coupled SAW resonator filter would be an optimum choice. In-line acoustic coupling was chosen since it is a reliable design technique that can provide sufficient bandwidth to accommodate the various manufacturing tolerances and because this coupling has been demonstrated to achieve low loss.⁹

TABLE 2

SAW FILTER ELECTRICAL SPECIFICATION GOALS

Frequency	950 MHZ
Bandwidth	300 KHZ Minimum 2.5 MHZ Maximum
Insertion Loss	<6 dB, 5 dB Goal
Rejection @ F ₀ ± 10 MHZ	30 dB Minimum
Temperature Range	0°C to 50°C
Input/Output Impedance	50 Ohm, VSWR 1.5:1 Max.
Package Size	0.30"x0.24"x 0.06"

The design of this filter utilized a scattering matrix analysis developed from the earlier work of those at Sawtek⁹ but is similar to that of Rosenberg and Colderen.⁷ Using this technique we were able to include the effects of the matching and coupling elements. This is imperative since the parasitics of these elements have a profound influence on the overall achievement of the electrical specifications. The following design parameters were used in this analysis.

Number of Wavelengths/Transducer	= 45
Aperture (in wavelengths)	= 100
Apodization	= Overlap
Number of Outside Reflectors	= 500
Number of Middle Reflectors	= 150
Metal Thickness	= 700Å

In order to minimize the in-band ripple the transducers of this filter have been apodize weighted to minimize the coupling to higher order transverse mode. This weighting technique is not as effective in suppressing the frequency sidelobes of the transversal response as the apodization/withdrawal technique described in Reference 9 but it is sufficient to meet the electrical specifications of this program.

The temperature stability of this filter was important to the extent that it should not increase the bandwidth requirement beyond a practically achievable limit of 0.2%. Therefore, a 40° single rotated Y cut quartz substrate was chosen to provide a 25°C turnover temperature.

Figure 7 is the predicted frequency response of this filter in the unmatched state resulting from a computer model utilizing the scattering matrix analysis technique described earlier is shown.

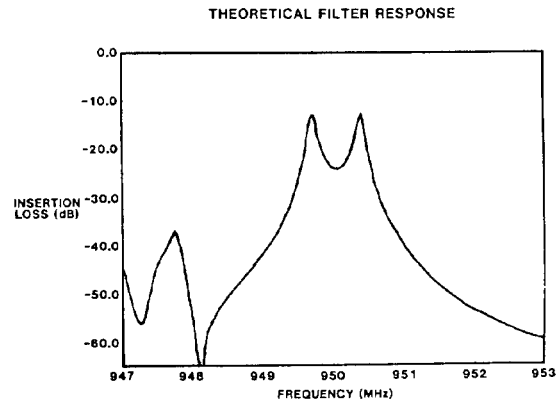

Figure 7

RESONATOR FILTER FABRICATION

The line widths of the reflector gratings and interdigital transducer patterns of this filter are nominally 0.82 um. The filter was patterned at 10x size using an electromask pattern generator and then stepped and repeated to final size on a ultraflat dark chrome photomask plate. The replication of this photo-mask was accomplished by contact photolithography using a mid UV light source. A 700 Angstrom aluminum film was magnetron sputtered on the quartz substrates and after resist patterning the excess metal was removed by chemical etching. The wafer was then diced for final assembly.

For the initial electrical evaluation these filters were assembled in TO-5 packages and matched with air wound inductors and adjustable capacitors. In the final form these filters will be packaged in a flatpack configuration similar to that shown in Figure 11. The inductors in this configuration are spiral planar chips which are internally manufactured and the capacitors are MOS types.

FILTER PERFORMANCE

The experimental unmatched transmission response is plotted in Figure 8. Good

agreement is obtained between this and the theoretical response shown in Figure 7. The input and output return loss are shown on a Smith Chart in Figure 9a from which a matching network is obtained.

A two-element matching network will theoretically transfer the filter characteristic impedance to 50 ohm. However, the bandwidth and insertion loss of the filter will be extremely sensitive to the manufacturing tolerances of the matching elements. To minimize these effects, a four-element matching network is chosen as shown on the Smith Chart in Figure 9b. The matched response is shown in Figure 10. The experimental results of the filter are listed in Table 3.

EXPERIMENTAL UNMATCHED FILTER RESPONSE

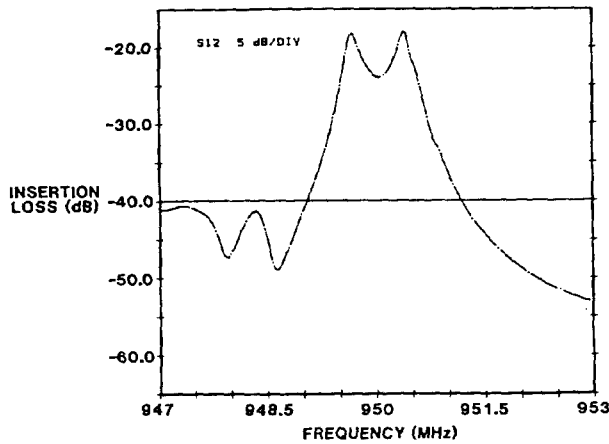
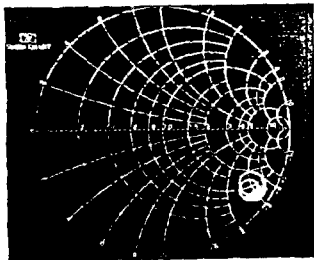

Figure 8

TWO-PORT SAW RESONATOR



FREQUENCY	950 MHz
APERTURE (in wavelengths)	100
TRANSDUCER LENGTH (in wavelengths)	45
APODIZATION	OVERLAP
NUMBER OF OUTSIDE REFLECTORS	500
NUMBER OF MIDDLE REFLECTORS	150
METAL THICKNESS	700 Å
SUBSTRATE	40° QUARTZ

Figure 9a

RESONATOR MATCHING NETWORK

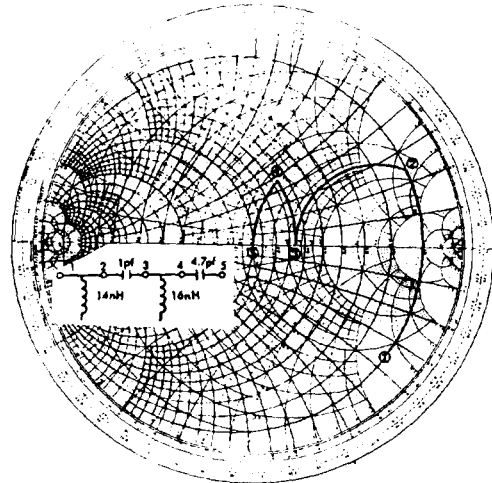

Figure 9b

EXPERIMENTAL MATCHED FILTER RESPONSE

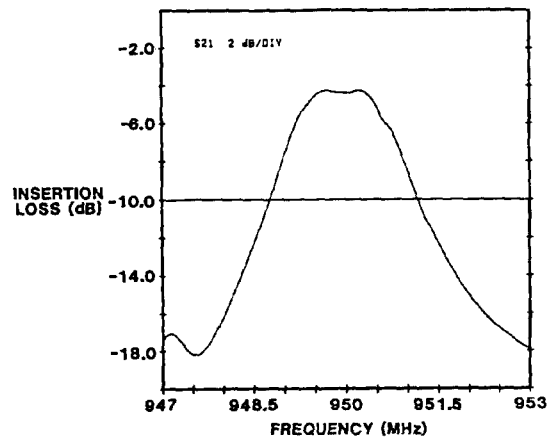

Figure 10

TABLE 3

FILTER EXPERIMENTAL RESULTS

Frequency	949.9 MHz
Bandwidth	900 KHz
Insertion Loss	4.7 DB
Temperature Range	0° - 50°C
VSWR	≤1.1
REJECTION @ F ₀ ±10 MHz	27 dB

The flatpack configuration of this filter is illustrated in Figure 11. This figure shows the two-pole SAW filter centered in the package and on either side of it are two spiral inductors and two chip capacitors. The package used is a custom made flatpack .300"W x .240"L x .085"H. The elements are mounted inside the flatpack using a conductive epoxy. The spiral inductors⁵ are designed to deliver the necessary inductance and fit in the package. They also serve to support the chip capacitors.

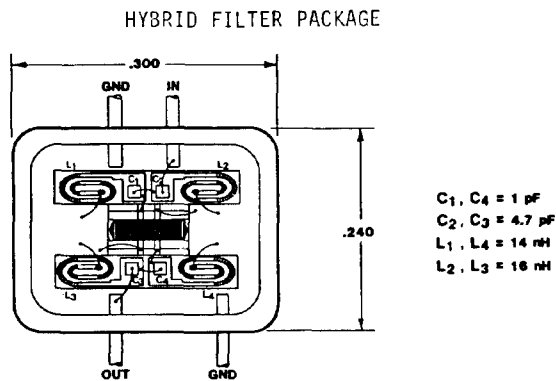

Figure 11

SUMMARY

The electrical performance of the SAW resonator controlled oscillator and SAW resonator filter are shown to be the state-of-the-art for components in this frequency range and of this physical size. The circuit designs are flexible enough to be tailored for other applications or frequencies in the 200 MHz to 1250 MHz range.

The temperature compensation scheme demonstrates a relatively simple and straight forward means with which to control the frequency of a SAW oscillator over a limited temperature range.

The resonator filter performance demonstrates that low insertion loss, minimum ripple and good rejection can be obtained in this frequency range. A subminiature configuration is suggested which includes all impedance matching elements.

At present the flatpack is considered to be the smallest realizable conventional type of package available. Further work is underway to develop a method of sealing hybrid circuits in situ by means of a multilevel co-fired ceramic ring with a seam welded lid. This approach is directed at achieving a package height of 0.06 inches.

ACKNOWLEDGEMENTS

The authors wish to thank E.C. Register and D. Jordan for device testing, B. Horine and Dr. H. van de Vaart for their suggestions, B. Laffler for her preparation of the illustrations, and C. Green for her preparation of this manuscript.

REFERENCES

1. D.E. Frerking, Crystal Oscillator Design and Temperature Compensation, Van Nostrand Reinhold Co., New York, 1978, Library of Congress Card No. 77-17876.
2. T. O'Shea, V. Sullivan, R. Kindell, "Precision L-Band SAW Oscillator for Satellite Application," Proc. 37th Annual Symposium on Frequency Control, U.S. Army ERADCOM, pp 394-404.
3. R.C. Kinsman, "Temperature Compensation of Crystals with Parabolic Temperature Coefficients," Proceedings 32nd Annual Symposium on Frequency Control, U.S. Army ERADCOM, pp 102-107.
4. W.D. Hutchins, "Microwave Design Utilization with A New Non-Ceramic, High-Dielectric Substrate," 1977 Conference Proceedings of ISHM.
5. S. Gopani, R. Brown, D. Shumate, "Integrated Phasing and Matching Networks in Printed Form for a Three-Phase Unidirectional Transducer," Proceedings of 1983 Ultrasonics Symposium, pp 41-46.
6. N.A. Howard, "GHz Thick Film Hybrid SAW Oscillators," Proceedings of 1983 Ultrasonic Symposium, pp 283-286.
7. R.L. Rosenberg, L.A. Coldren, "Scattering Analysis and Design of SAW Resonator Filters," IEEE Transactions on Sonics and Ultrasonics, Vol. SU-26, No. 3, May 1979.
8. G.S. Matthaël, E.B. Savage and F. Barman, "Synthesis of SAW Resonator Filters Using Any of Various Coupling Mechanisms," IEEE Transactions on Sonics and Ultrasonics, Vol. SU-26, pp 72-84, March 1978.
9. T. O'Shea, R. Rosenfeld, "SAW Resonator Filters With Optimized Transducer Rejection," Proceedings of 1981 Ultrasonics Symposium, pp 105-110.