

EM Implosion Memos

Memo 40

February 2010

Optimization of the feed arm and loft lengths for the truncated four feed arms with switch cones (T4FASC) configuration

Prashanth Kumar, Serhat Altunc, Carl E. Baum, Christos G. Christodoulou and Edl Schamiloglu
University of New Mexico
Department of Electrical and Computer Engineering
Albuquerque, NM 87131

Abstract

This paper presents results from numerical simulations investigating the feed arm and loft lengths for the T4FASC configuration. The lengths of the feed arms and loft connections are treated as parameters that need to be optimized to obtain the maximum focal impulse amplitude.

1 Introduction

The T4FASC configuration explored in [1] was found to be one of the more promising designs. However, the lengths of the feed arms and loft connections were arbitrarily chosen for the simulations [1]. This paper considers the feed arm and loft lengths as parameters that need to be optimized to maximize the focal impulse amplitude. Results from numerical simulations investigating these parameters are presented.

2 Setup

The setup is almost identical to the T4FASC configuration in [1]. Figure 2.1 shows the perspective view of the T4FASC and reflector system. The side view and geometrical details of the vertical switch cones and loft connections are shown in Fig. 2.2.

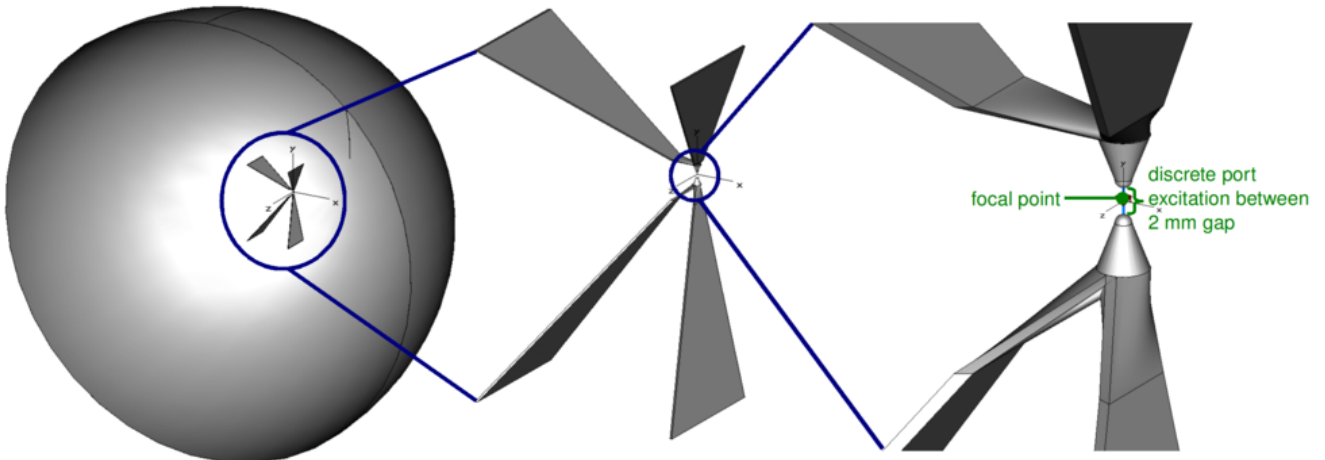

Figure 2.1: Perspective view of the four feed arms with switch cones and reflector system; “Zoomed-in” view, around first focal point, showing the discrete port excitation.

The loft length is y , and the feed arm length is l_{FA} , Fig. 2.2,. The tips of the switch cones are rounded to emulate a more practical design. The (virtual) apex of the cones meet at the first focal point. The impedance of the switch cones is $Z_c = 100 \Omega$, i.e., $\theta = 21.37^\circ$ [2]. In Fig. 2.2(b), r' is the radius of the spherical tip, h_{swgp} is the switch gap spacing, $h = 0.5$ cm is the height of the switch cone and r is the radius of the switch cone. Noting that $h' \tan \theta = r'$, r' is determined as

$$\frac{h_{swgp}}{2} + r' = h' \Rightarrow r' = \frac{h_{swgp}}{2} \left(\frac{\tan \theta}{1 - \tan \theta} \right). \quad (2.1)$$

For $h_{swgp} = 0.2$ cm, $r' = 0.64$ mm.

The excitation and CST simulation parameters are identical to those in [1].

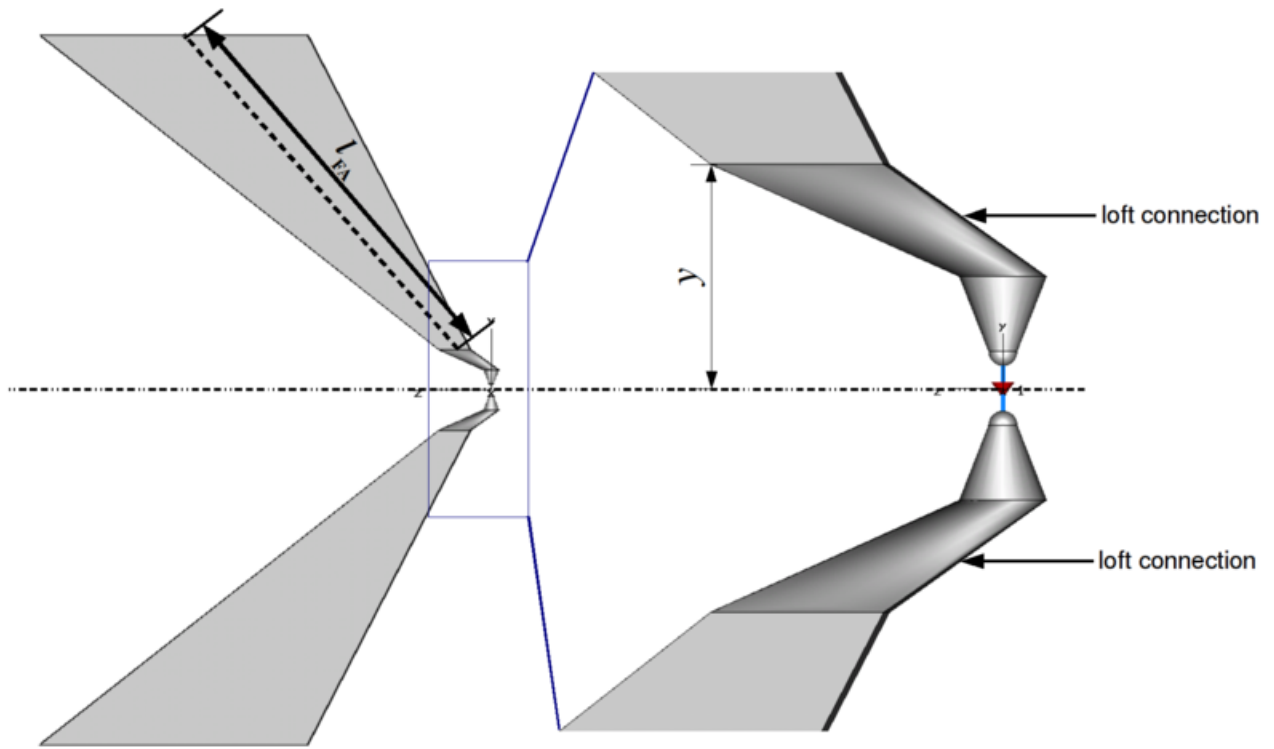

(a) Side view of the feed arms and the switch cones.

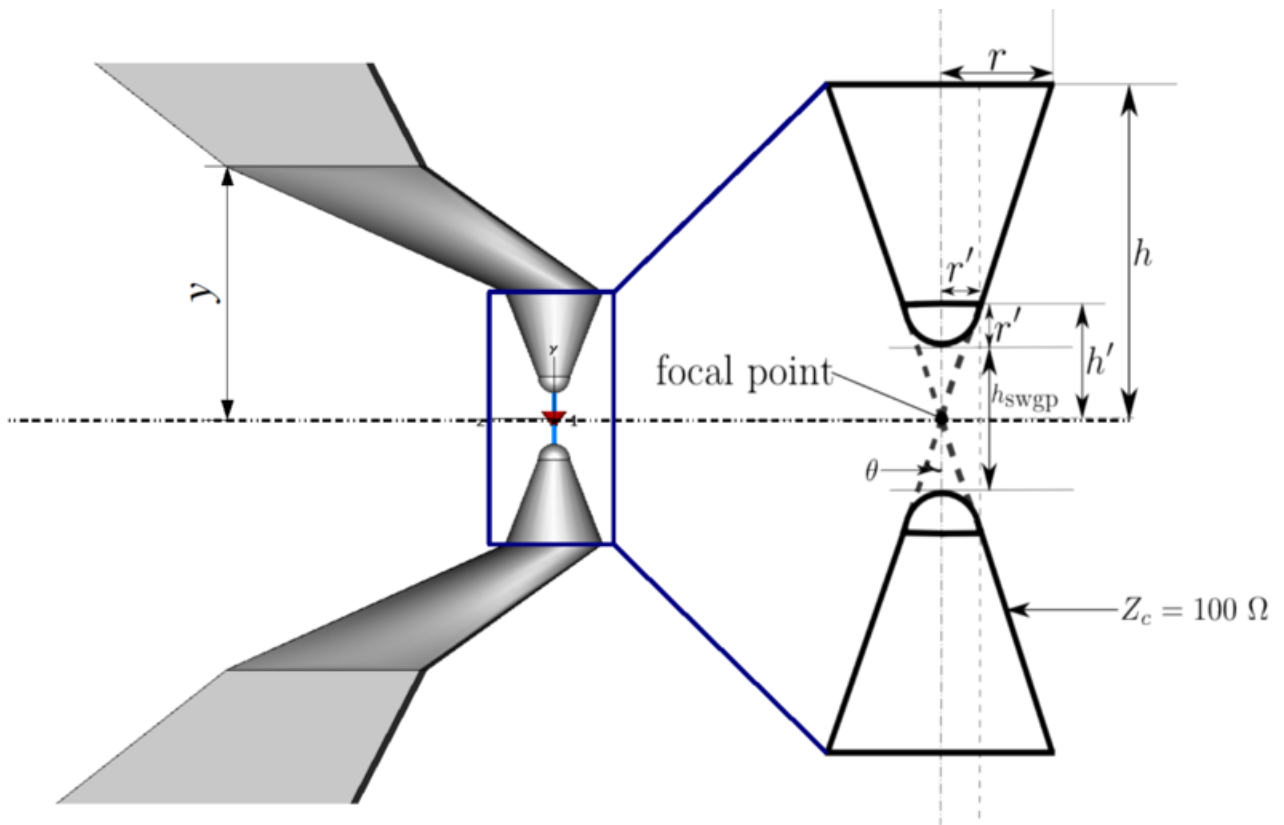

(b) Geometrical details of the switch cones.

Figure 2.2: Side view and geometrical details of the feed arms and the switch cones.

3 Results

3.1 Variation of the feed arm length

The feed arm length, l_{FA} , is varied to examine its effects on the focal impulse amplitude and beam width. The loft length is fixed at $y = 1.0$ cm.

The spherical TEM wave originating from the first focal point is guided by the vertical switch cones, loft connections and feed arms. If the effective electrical length of these guiding structures is less than $ct_\delta = 3.0$ cm, the focal impulse response resonates in time, as verified in Fig. 3.1 where $l_{\text{FA}} = 0.5$ cm; as expected from clear time considerations.

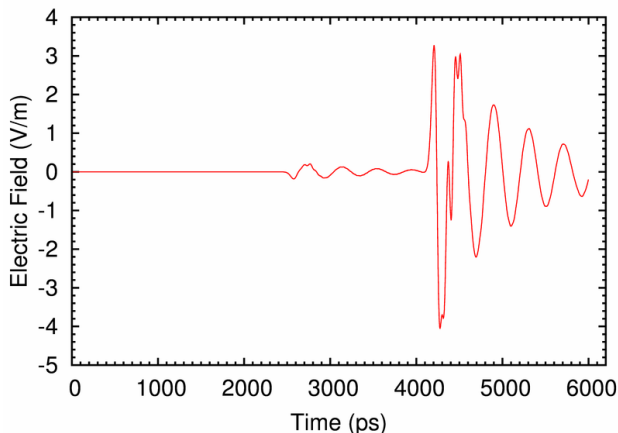

Figure 3.1: Focal impulse waveform for feed arm length of 0.5 cm.

Fig. 3.2 shows the variation of the peak focal impulse electric field, E_{max} , and spot size versus l_{FA} . One notes a sharp maximum in the E_{max} and spot size curves. The maximum focal impulse amplitude, $E_{\text{max}} = 7.53$ V/m, occurs at $l_{\text{FA}} = 18.0$ cm. For comparison, consider $l_{\text{FA}} = 46.9$ cm. The relative increase in E_{max} from $l_{\text{FA}} = 18.0$ cm to $l_{\text{FA}} = 46.9$ cm is 14% while the corresponding relative increase in spot size is only 8.6%.

Focal waveforms and spot sizes for various l_{FA} are given in Appendix-I. One notes the evolution of the prepulse as the length of the feed arms is increased.

3.2 Variation of the loft length

The loft length, y , is varied to examine its effect on the focal impulse amplitude and the beam width. The total length of the feed arms and the loft connections is fixed such that $l_{\text{FA}} = 18.0$ cm @ $y = 1.0$ cm. For $y \gtrsim ct_\delta = 3.0$ cm, the first t_δ seconds of the wave is guided only by the switch cones and the loft connections.

Fig. 3.3 shows the variation of E_{max} and spot size versus the loft length. The peak focal impulse amplitude increases with y . This is most likely because a longer loft connection transitions more smoothly from the switch cones to the feed arms. The maximum focal impulse amplitude is $E_{\text{max}} = 7.93$ V/m @ $y = 8.0$ cm. Note that there is only a 5% increase in E_{max} , and 2.5% decrease in spot size, from $y = 0.75$ cm to $y = 8.0$ cm.

Focal waveforms and spot sizes for various loft lengths are given in Appendix-II.

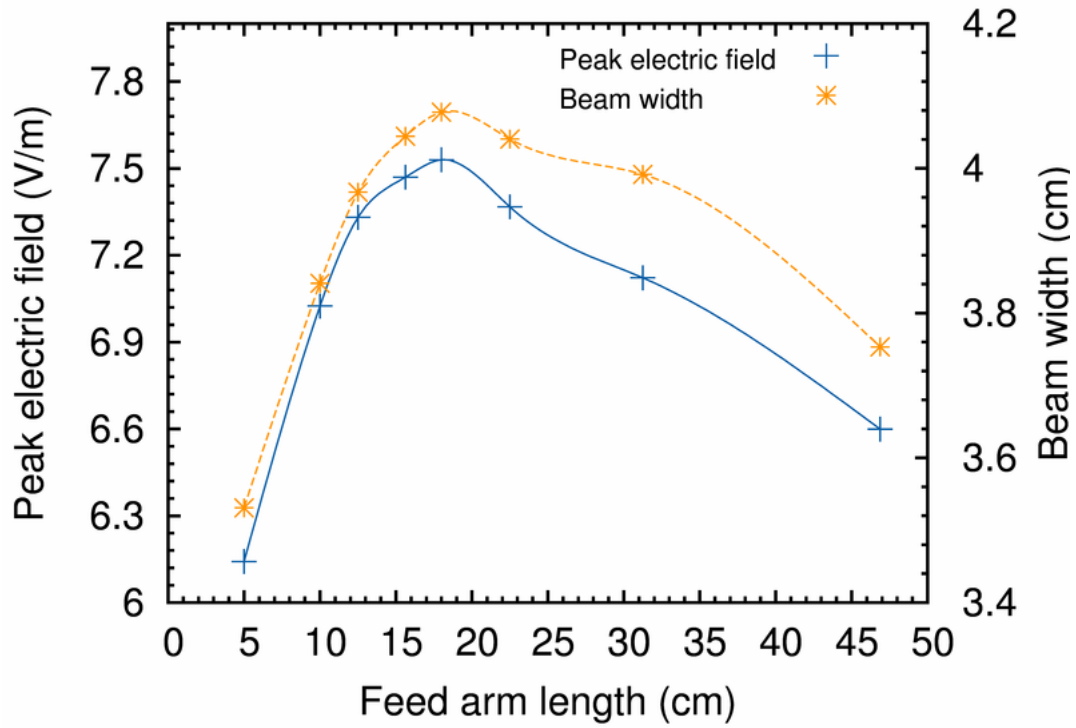

Figure 3.2: Peak focal impulse amplitude and beam width for various feed arm lengths; the left length $y = 1.0$ cm.

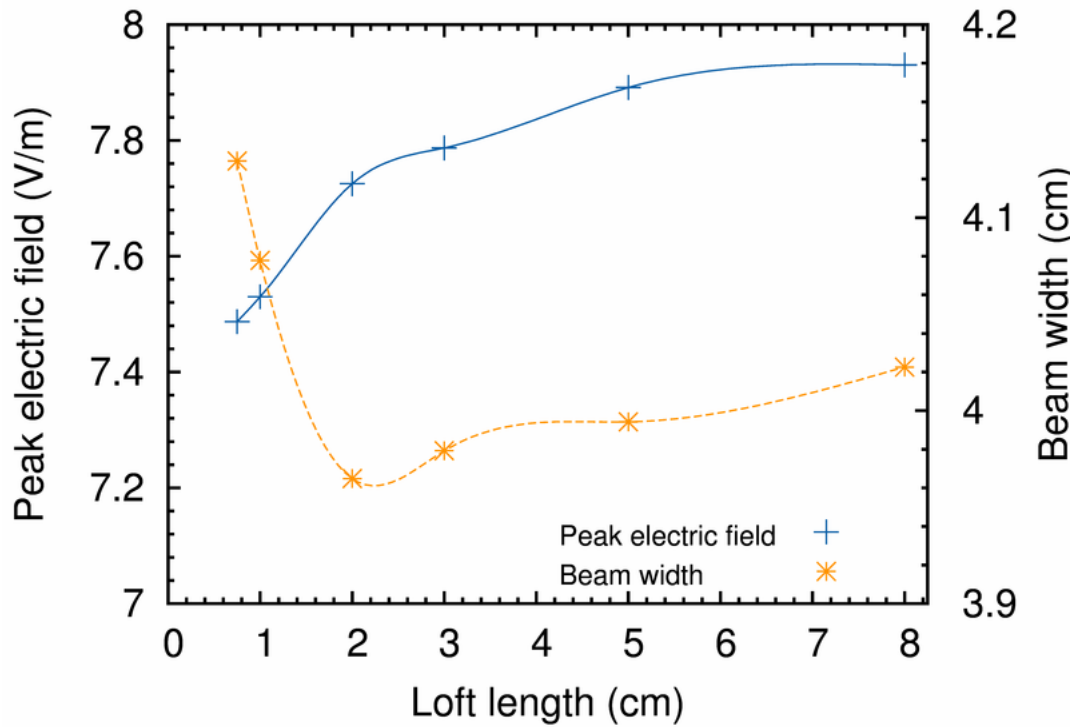

Figure 3.3: Peak focal impulse amplitude and beam width for various loft lengths.

4 Conclusions

For a loft length of $y = 1.0$ cm, an $l_{\text{FA}} = 18.0$ cm is found to yield the highest E_{max} . Additionally, the increase in spot size for $l_{\text{FA}} = 18.0$ cm is less than 10% compared to other l_{FA} investigated, which is practically desirable.

The length of the loft connections do not significantly affect the focal impulse amplitude or the beam width, Fig. 3.3. However, the average E_{max} , 7.73 V/m, is higher than the E_{max} obtained for any l_{FA} in Fig. 3.2, albeit with a very small compromise in the spot size. *This leads one to conclude that the loft connections, of length $y \gtrsim 3.0$ cm, are sufficient to guide the waves, and that the feed arms are unnecessary.*

References

- [1] Prashanth Kumar, Carl E. Baum, Serhat Altunc, Christos G. Christodoulou and Edl Schamiloglu . Investigation of various switch configurations. EM Implosion Memo 38, February 2010.
- [2] Carl E. Baum. A Circular Conical Antenna Simulator. Sensor and Simulation Note 36, March 1967.

APPENDIX-I

Focal waveform and beam width for various feed arm truncation lengths. Loft length $y = 1.0$ cm.

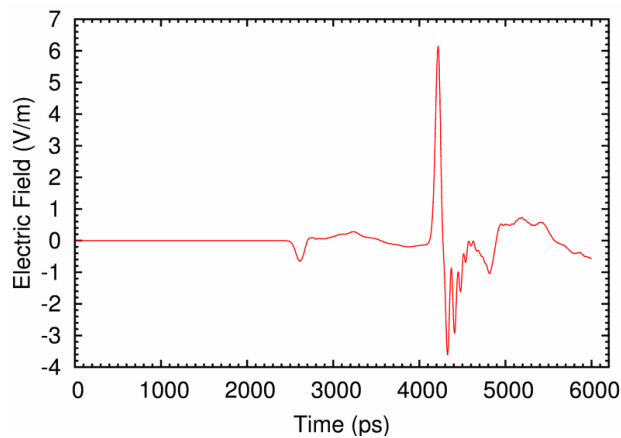

(a) $l_{FA} = 5.0$ cm

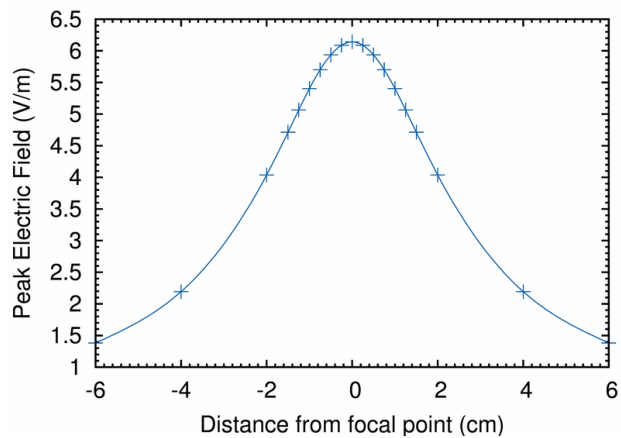

(b) $l_{FA} = 5.0$ cm

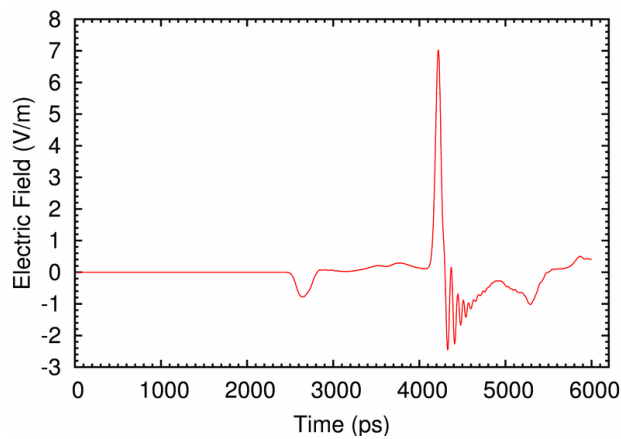

(c) $l_{FA} = 10.0$ cm

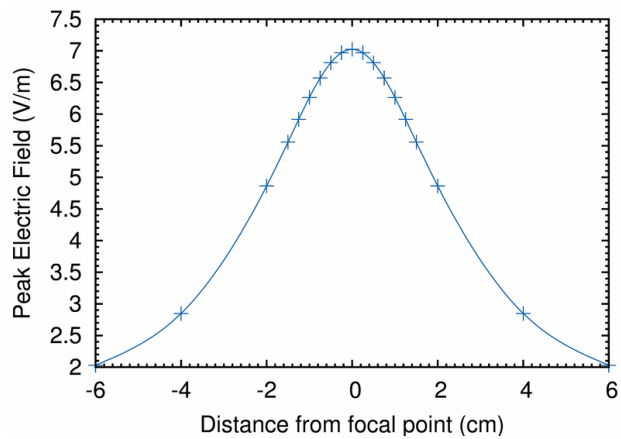

(d) $l_{FA} = 10.0$ cm

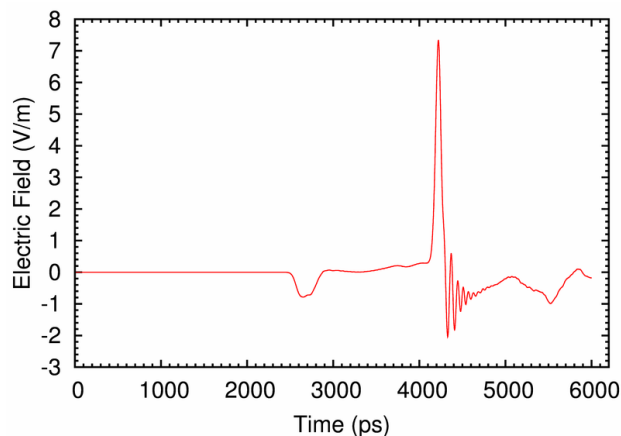

(e) $l_{FA} = 12.5$ cm

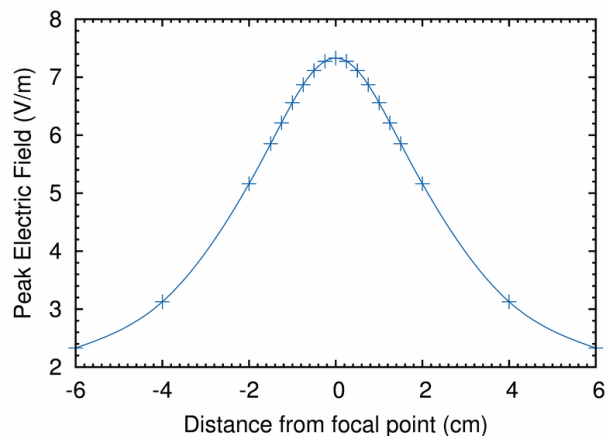

(f) $l_{FA} = 12.5$ cm

Figure 4.1: Focal impulse waveforms and spot sizes for various feed arm lengths (Part I of III).

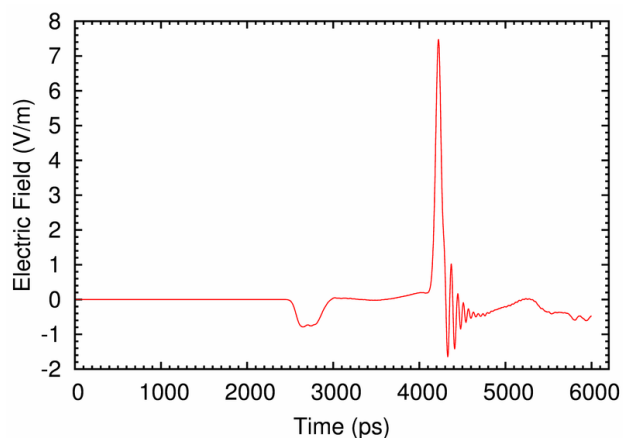

(a) $l_{\text{FA}} = 15.625$ cm

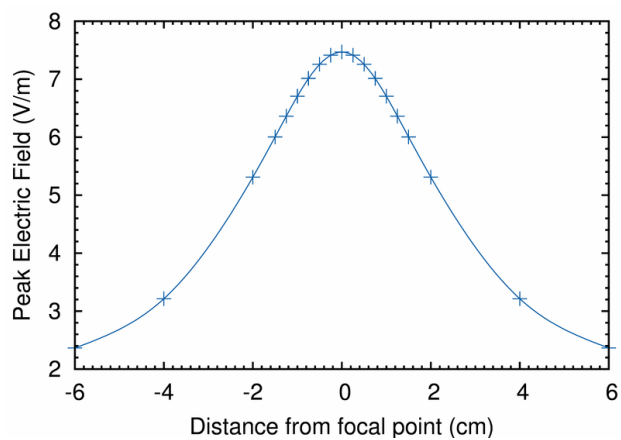

(b) $l_{\text{FA}} = 15.625$ cm

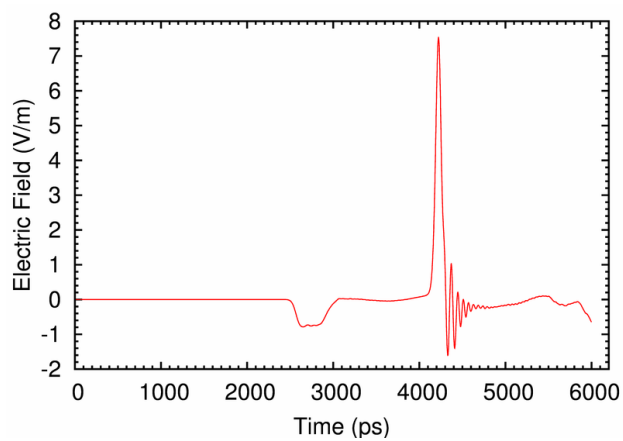

(c) $l_{\text{FA}} = 18.0$ cm

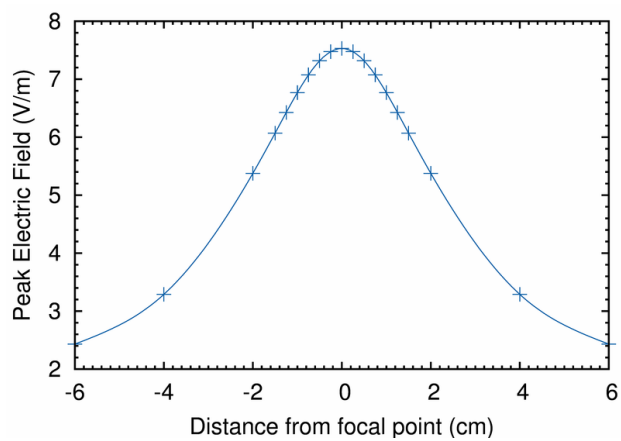

(d) $l_{\text{FA}} = 18.0$ cm

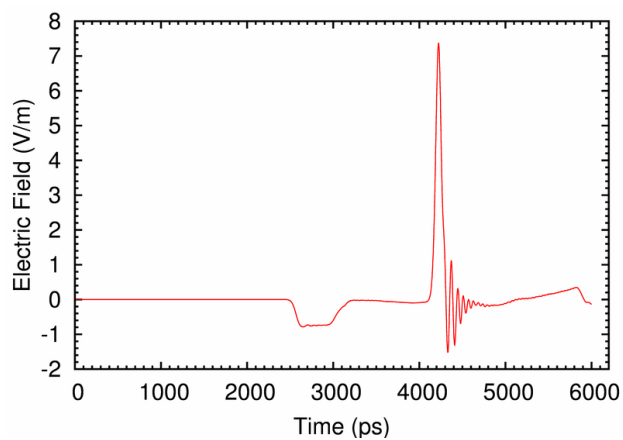

(e) $l_{\text{FA}} = 22.5$ cm

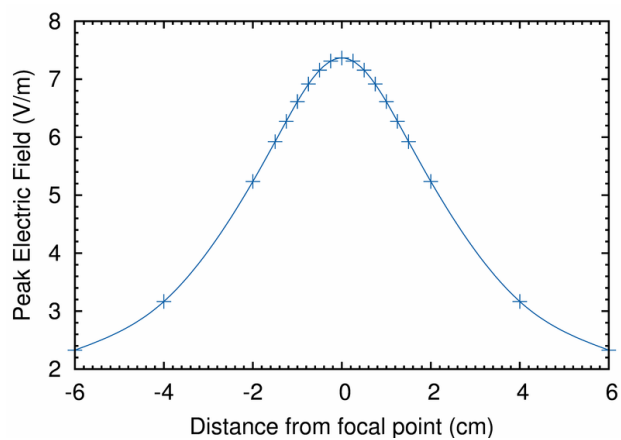

(f) $l_{\text{FA}} = 22.5$ cm

Figure 4.2: Focal impulse waveforms and spot sizes for various feed arm lengths (Part II of III).

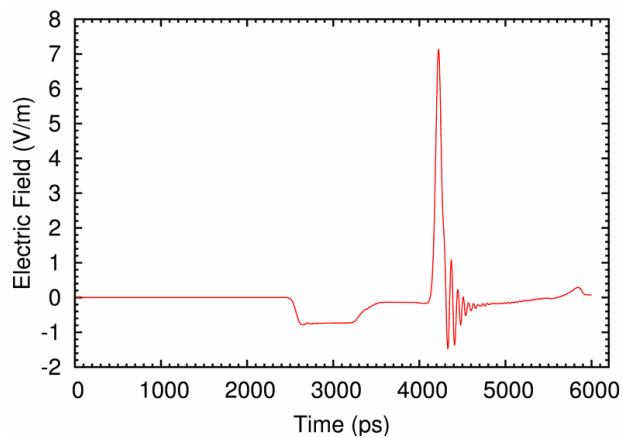

(a) $l_{\text{FA}} = 31.25$ cm

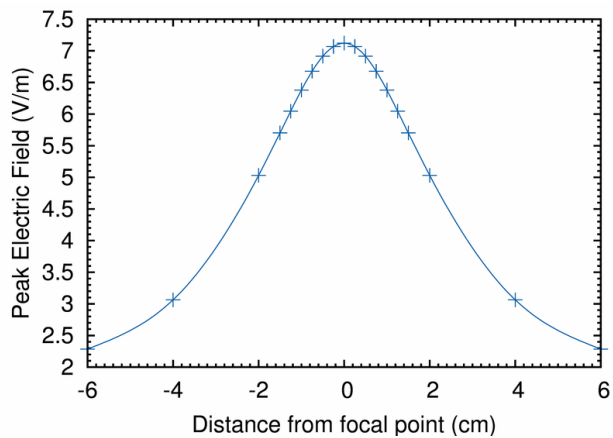

(b) $l_{\text{FA}} = 31.25$ cm

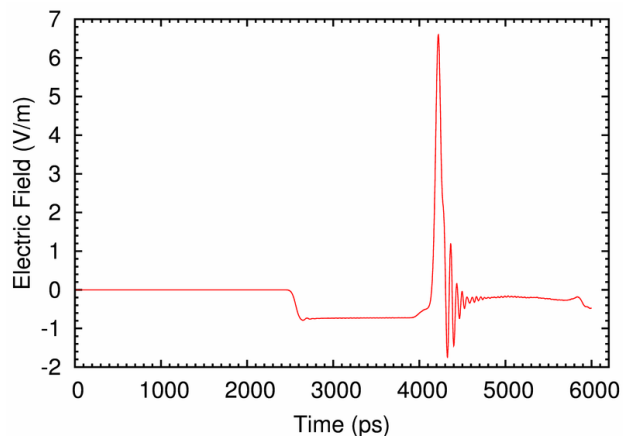

(c) $l_{\text{FA}} = 46.875$ cm

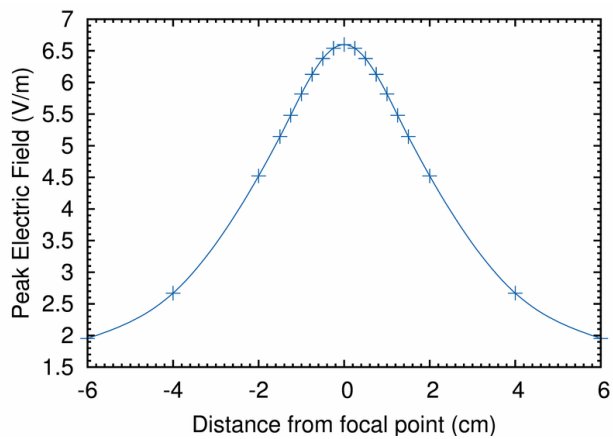

(d) $l_{\text{FA}} = 46.875$ cm

Figure 4.3: Focal impulse waveforms and spot sizes for various feed arm lengths (Part III of III).

APPENDIX-II

Focal waveform and beam width for various loft lengths.

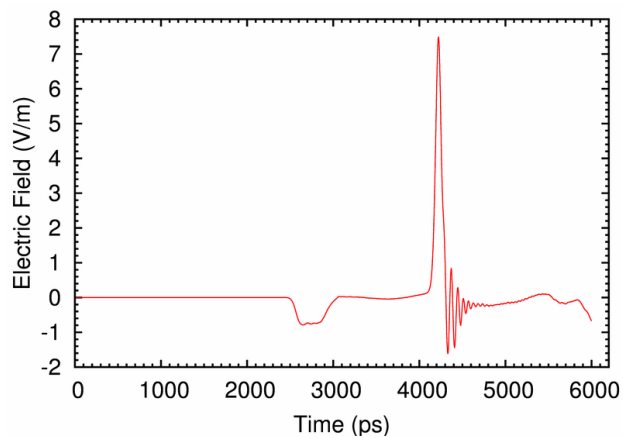

(a) $y = 5.0$ cm

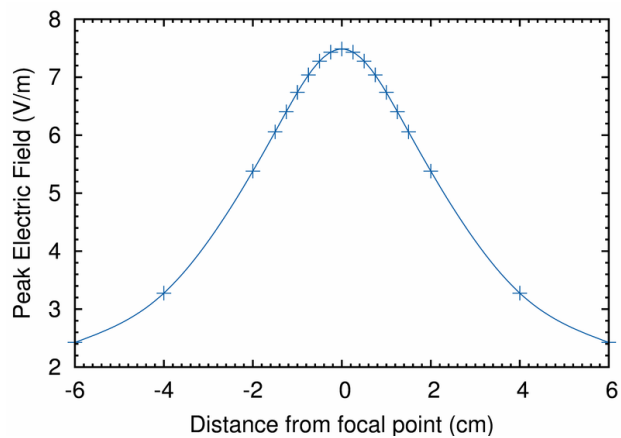

(b) $y = 5.0$ cm

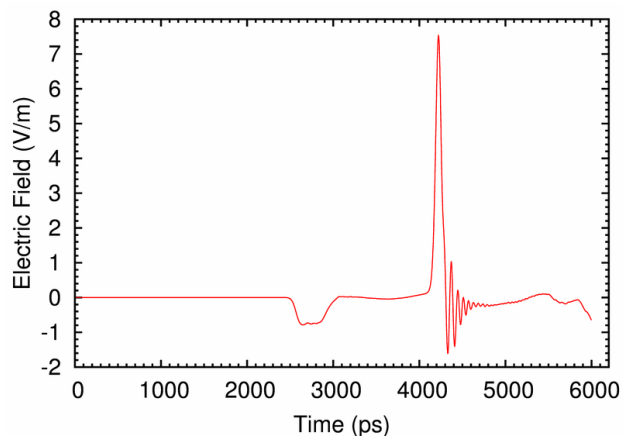

(c) $y = 1.0$ cm

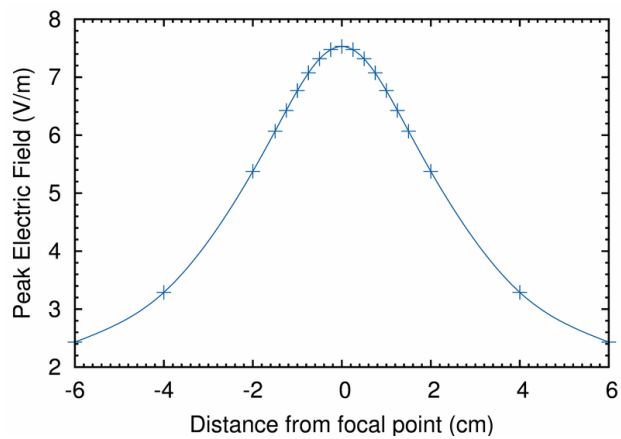

(d) $y = 1.0$ cm

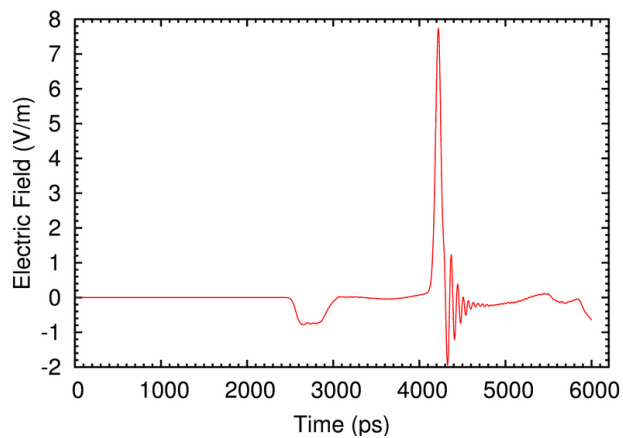

(e) $y = 2.0$ cm

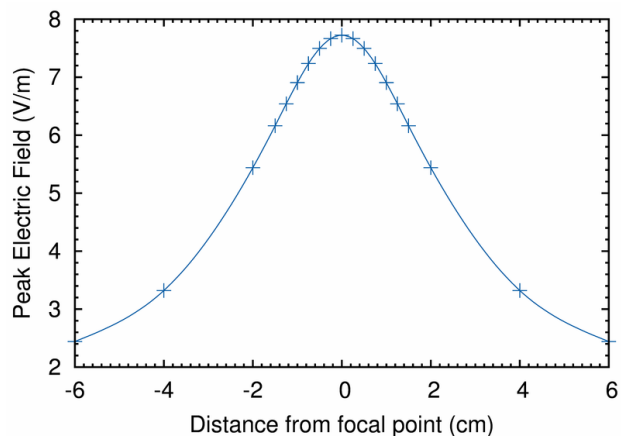

(f) $y = 2.0$ cm

Figure 4.4: Focal impulse waveforms and spot sizes for various loft lengths (Part I of II).

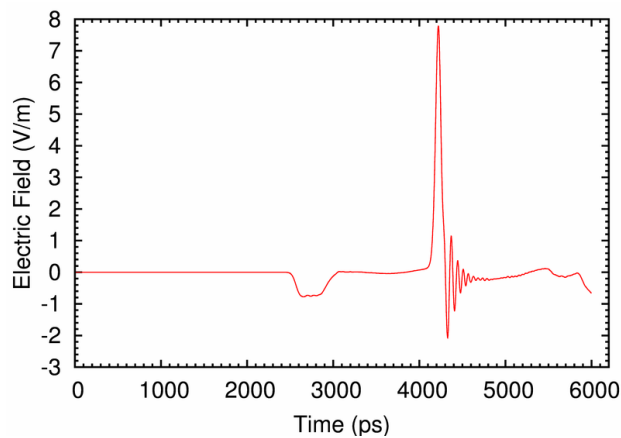

(a) $y = 3.0$ cm

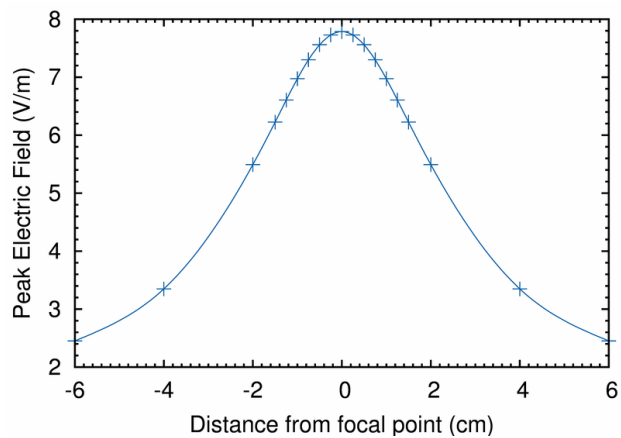

(b) $y = 3.0$ cm

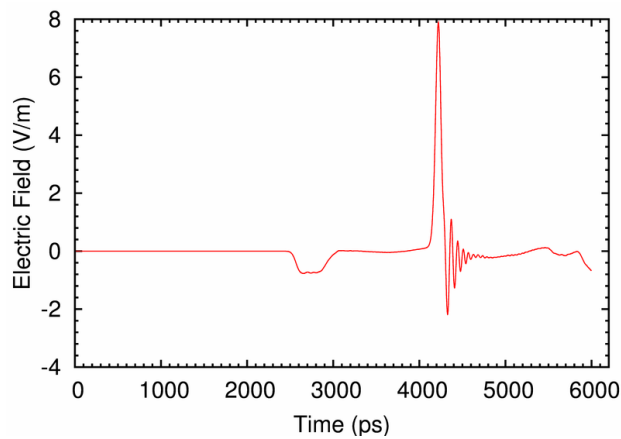

(c) $y = 5.0$ cm

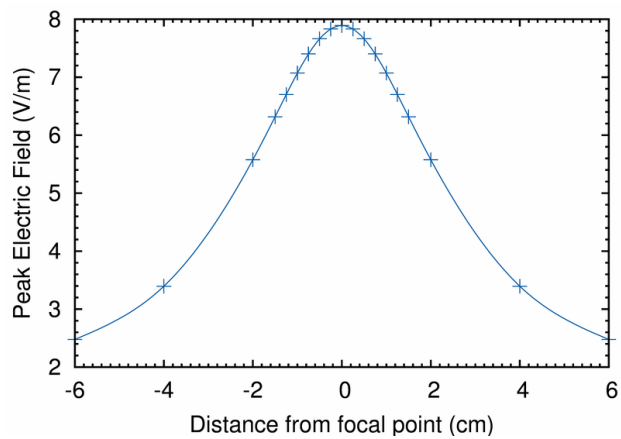

(d) $y = 5.0$ cm

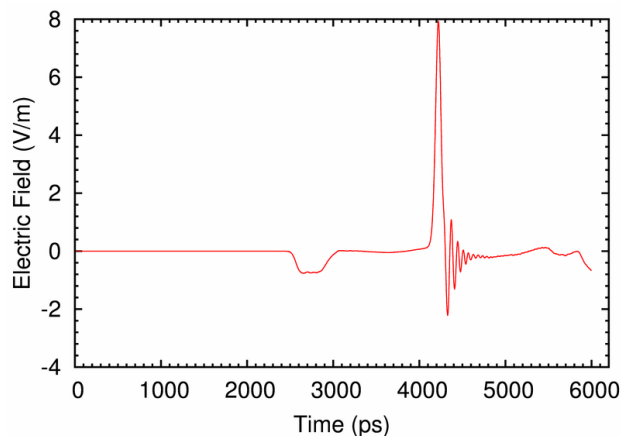

(e) $y = 8.0$ cm

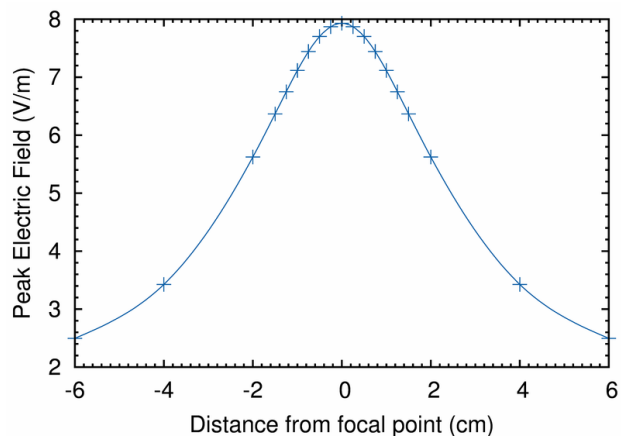

(f) $y = 8.0$ cm

Figure 4.5: Focal impulse waveforms and spot sizes for various loft lengths (Part II of II).